



PESD2IVN24-T

ESD protection for In-vehicle networks

19 November 2025

Product data sheet

1. General description

ESD protection device in a small SOT23 (TO-236AB) Surface-Mounted Device (SMD) plastic package designed to protect two automotive In-vehicle network bus lines from the damage caused by ElectroStatic discharge (ESD) and other transients.

2. Features and benefits

- Reverse stand-off voltage: $V_{RWM} = 24\text{ V}$
- Low clamping voltage: $V_{CL} = 33\text{ V}$ at $I_{PP} = 3.5\text{ A}$
- Typ. diode capacitance matching: $\Delta C_d/C_d = 0.1\%$
- ESD protection up to 30 kV (IEC 61000-4-2)
- ESD protection up to 30 kV (ISO 10605; $C = 330\text{ pF}$, $R = 330\ \Omega$)
- ISO 7637-3: Pulse a: $V_S = -150\text{ V}$ / Pulse b: $V_S = +100\text{ V}$
- Ultra low leakage current: $I_{RM} < 1\text{ nA}$
- Qualified according to AEC-Q101 / Automotive grade

3. Applications

ESD protection for In-vehicle network lines in automotive environments

- CAN
- LIN
- FlexRay
- SENT

4. Quick reference data

Table 1. Quick reference data

| Symbol | Parameter | Conditions | | Min | Typ | Max | Unit |
|-----------|--------------------------|---|---------|-----|-----|-----|------|
| V_{RWM} | reverse standoff voltage | $T_{amb} = 25\text{ }^\circ\text{C}$ | | - | - | 24 | V |
| I_{PPM} | rated peak pulse current | $t_p = 8/20\ \mu\text{s}$ | [1] [2] | - | - | 3.5 | A |
| V_{CL} | clamping voltage | $I_{PPM} = 3.5\text{ A}$; $t_p = 8/20\ \mu\text{s}$; $T_{amb} = 25\text{ }^\circ\text{C}$ | [3] [2] | - | 33 | 42 | V |

[1] According to IEC 61000-4-5.

[2] Measured from pin 1 or 2 to pin 3.

[3] Device stressed with 8/20 μs exponential decay waveform according to IEC 61000-4-5.

5. Pinning information

Table 2. Pinning information

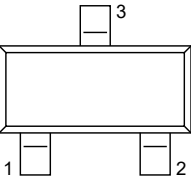
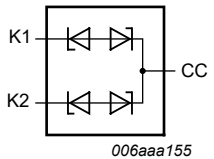
| Pin | Symbol | Description | Simplified outline | Graphic symbol |
|-----|--------|-------------------|---|---|
| 1 | K1 | cathode (diode 1) |  <p style="text-align: center;">SOT23</p> |  |
| 2 | K2 | cathode (diode 2) | | |
| 3 | K | common cathode | | |

6. Ordering information

Table 3. Ordering information

| Type number | Package | | |
|--------------|---------|--|---------|
| | Name | Description | Version |
| PESD2IVN24-T | SOT23 | plastic, surface-mounted package; 3 terminals; 1.9 mm pitch; 2.9 mm x 1.3 mm x 1 mm body | SOT23 |

7. Marking

Table 4. Marking codes

| Type number | Marking code ^[1] |
|--------------|-----------------------------|
| PESD2IVN24-T | BV% |

[1] % = placeholder for manufacturing site code

8. Limiting values

Table 5. Limiting values

In accordance with the Absolute Maximum Rating System (IEC 60134).

| Symbol | Parameter | Conditions | | Min | Max | Unit |
|----------------------------|---------------------------------|--|---------|-----|-----|------|
| I_{PPM} | rated peak pulse current | $t_p = 8/20 \mu s$ | [1] [2] | - | 3.5 | A |
| T_j | junction temperature | | | - | 150 | °C |
| T_{amb} | ambient temperature | | | -55 | 150 | °C |
| T_{stg} | storage temperature | | | -65 | 150 | °C |
| ESD maximum ratings | | | | | | |
| V_{ESD} | electrostatic discharge voltage | IEC 61000-4-2; contact discharge | [2] [3] | - | 30 | kV |
| | | ISO 10605; contact discharge; C = 330 pF, R = 330 Ω | [2] [3] | - | 30 | kV |
| | | ISO 10605; contact discharge; C = 150 pF, R = 330 Ω | [2] [3] | - | 30 | kV |

- [1] According to IEC 61000-4-5.
- [2] Measured from pin 1 or 2 to pin 3.
- [3] Device stressed with ten non-repetitive ESD pulses.

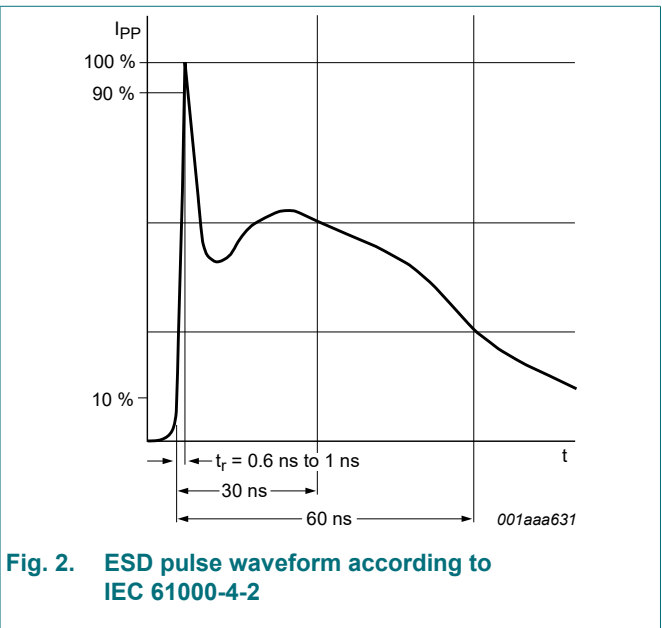
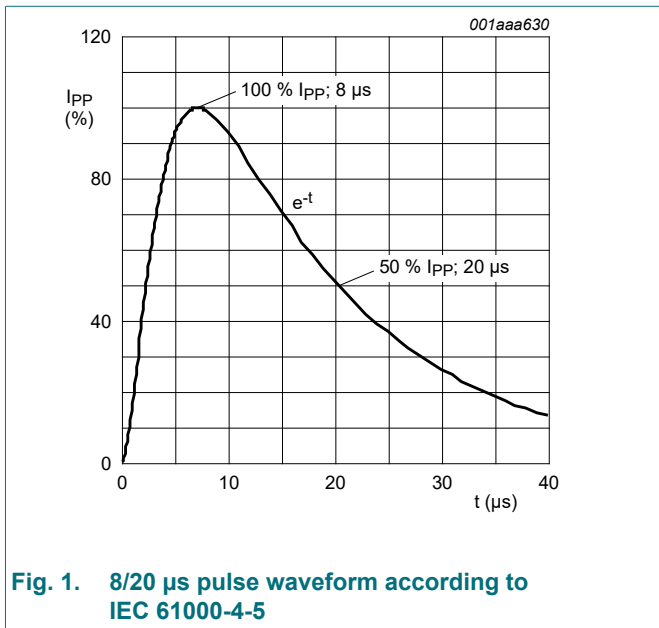

9. Characteristics

Table 6. Characteristics

| Symbol | Parameter | Conditions | | Min | Typ | Max | Unit |
|------------------|----------------------------|---|---------|------|------|------|----------|
| V_{RWM} | reverse standoff voltage | $T_{amb} = 25\text{ °C}$ | | - | - | 24 | V |
| V_{BR} | breakdown voltage | $I_R = 10\text{ mA}; T_{amb} = 25\text{ °C}$ | [1] | 25.5 | 30.5 | 35.5 | V |
| I_{RM} | reverse leakage current | $V_{RWM} = 24\text{ V}; T_{amb} = 25\text{ °C}$ | [1] | - | 1 | 50 | nA |
| C_d | diode capacitance | $f = 1\text{ MHz}; V_R = 0\text{ V}; T_{amb} = 25\text{ °C}$ | [1] | - | 14 | 17 | pF |
| $\Delta C_d/C_d$ | diode capacitance matching | $f = 1\text{ MHz}; V_R = 2.5\text{ V}; T_{amb} = 25\text{ °C}$ | [2] | - | 0.1 | - | % |
| V_{CL} | clamping voltage | $I_{PPM} = 1\text{ A}; t_p = 8/20\text{ }\mu\text{s}; T_{amb} = 25\text{ °C}$ | [3] [1] | - | 31 | 40 | V |
| | | $I_{PPM} = 3.5\text{ A}; t_p = 8/20\text{ }\mu\text{s}; T_{amb} = 25\text{ °C}$ | [3] [1] | - | 33 | 42 | V |
| | | $I_{PP} = 16\text{ A}; t_p = \text{TLP}; T_{amb} = 25\text{ °C}$ | [4] [1] | - | 32 | - | V |
| R_{dyn} | dynamic resistance | $I_R = 10\text{ A}; T_{amb} = 25\text{ °C}$ | [4] [1] | - | 0.2 | - | Ω |

- [1] Measured from pin 1 or 2 to pin 3.
- [2] ΔC_d is the difference of the capacitance measured between pin 1 and pin 3 and the capacitance measured between pin 2 and pin 3.
- [3] Device stressed with 8/20 μs exponential decay waveform according to IEC 61000-4-5.
- [4] Non-repetitive current pulse, Transmission Line Pulse (TLP); square pulse; ANSI / ESD STM5.5.1-2008

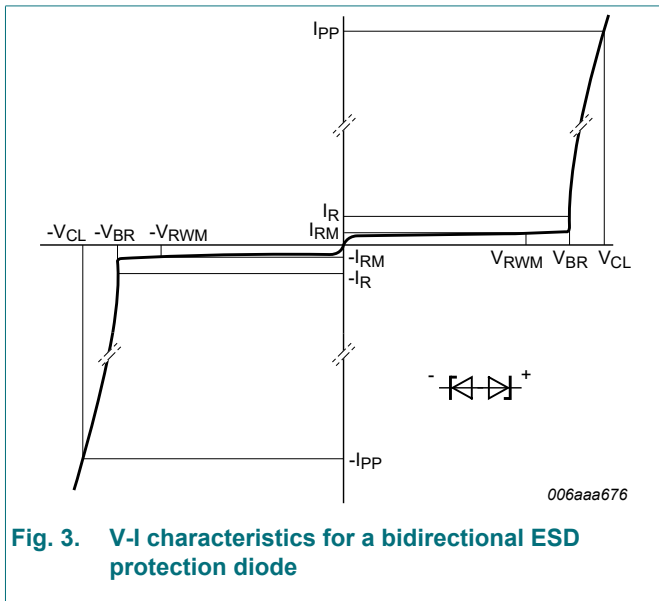

Fig. 3. V-I characteristics for a bidirectional ESD protection diode

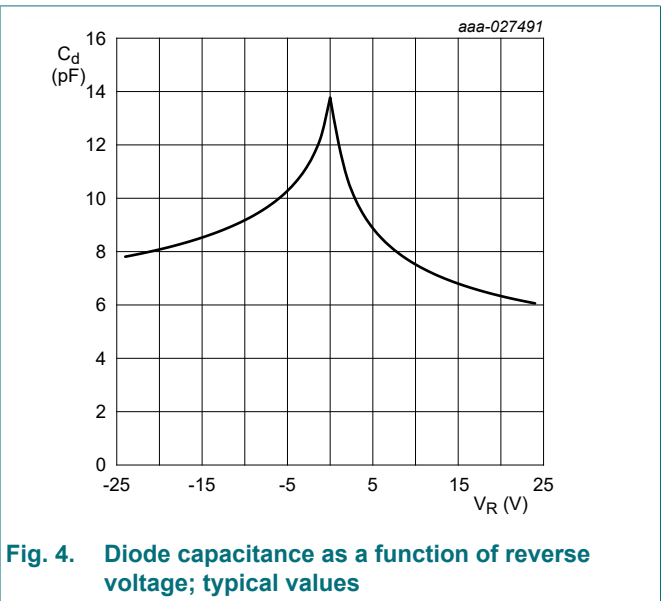
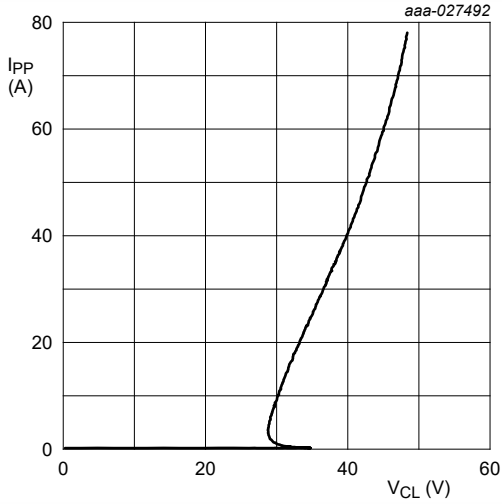
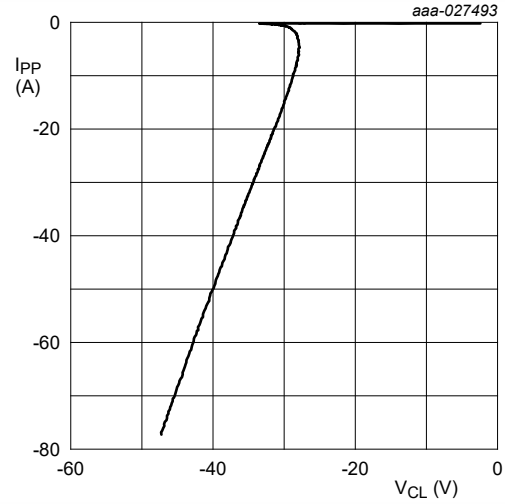

Fig. 4. Diode capacitance as a function of reverse voltage; typical values



$t_p = 100$ ns; Transmission Line Pulse (TLP)

Fig. 5. Positive clamping voltage (TLP); typical values



$t_p = 100$ ns; Transmission Line Pulse (TLP)

Fig. 6. Negative clamping voltage (TLP); typical values

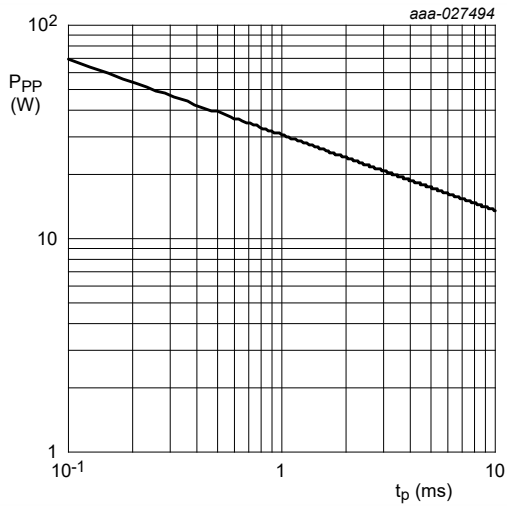

Fig. 7. Peak pulse power as a function of exponential pulse duration; typical values

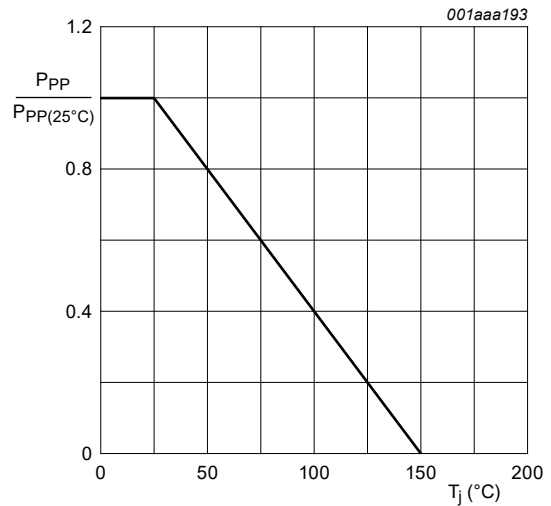

Fig. 8. Relative variation of peak pulse power as a function of junction temperature; typical values

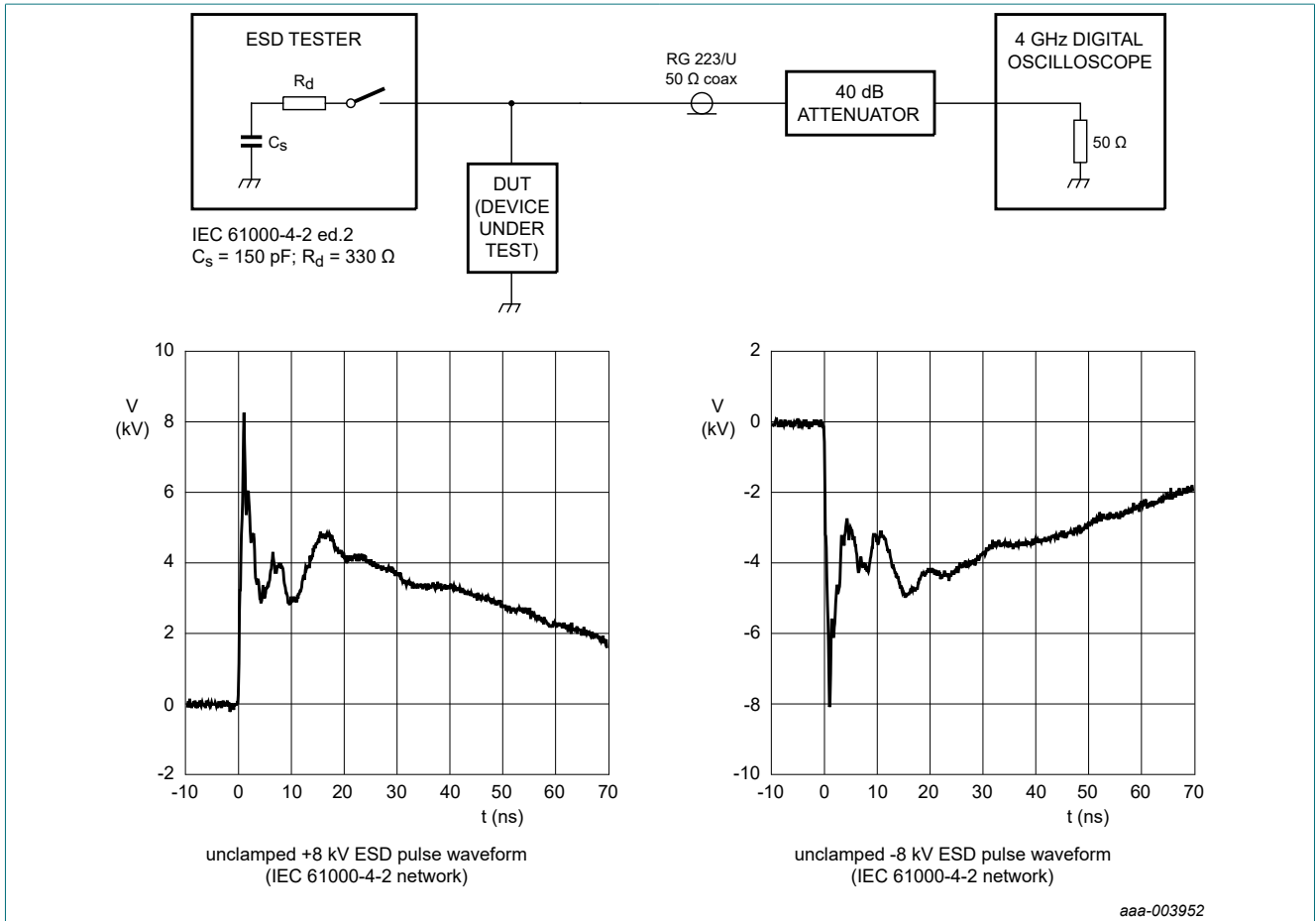

Fig. 9. ESD clamping test setup and waveforms

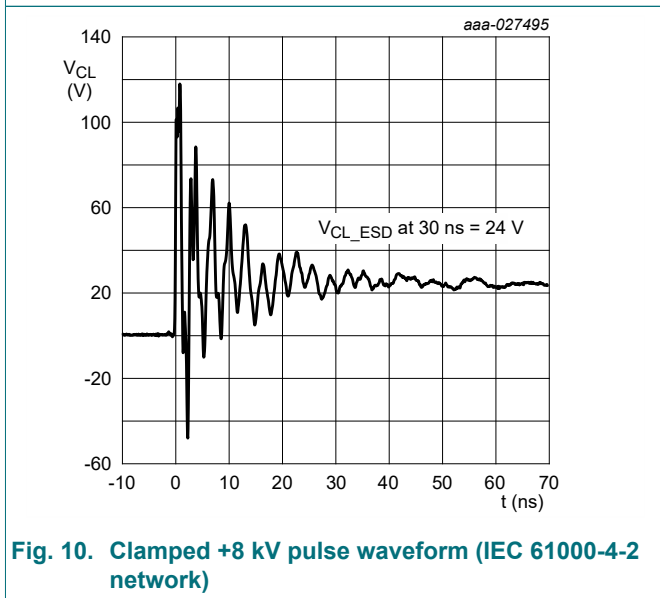

Fig. 10. Clamped +8 kV pulse waveform (IEC 61000-4-2 network)

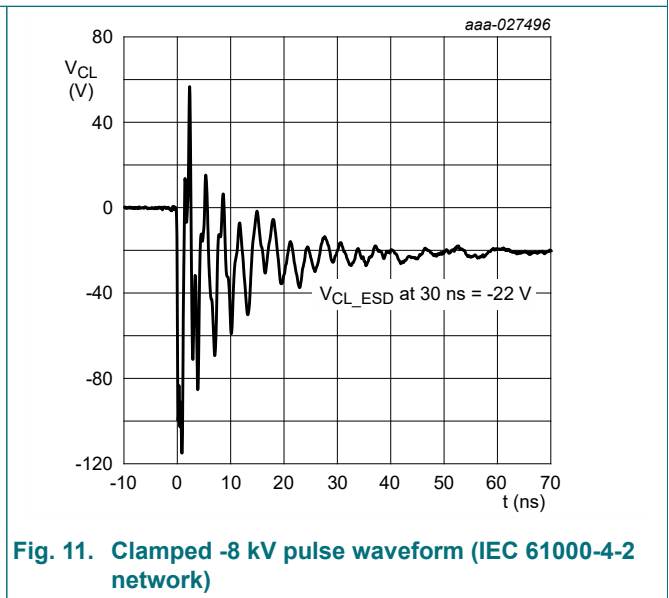

Fig. 11. Clamped -8 kV pulse waveform (IEC 61000-4-2 network)

10. Application information

The device is designed for the protection of two automotive IVN bus lines from the damage caused by ESD and surge pulses.

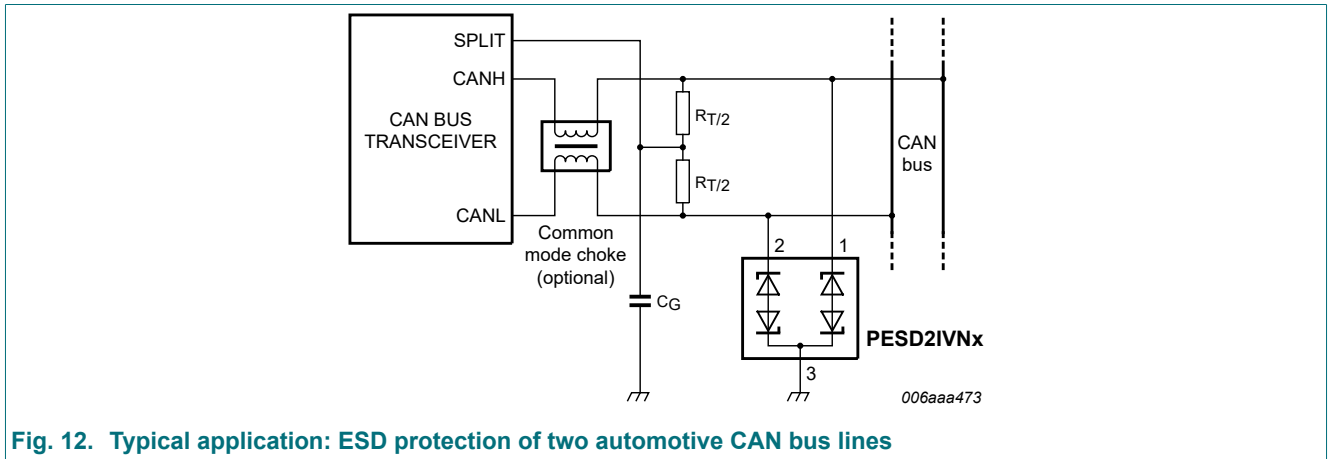

Fig. 12. Typical application: ESD protection of two automotive CAN bus lines

Circuit board layout and protection device placement

Circuit board layout is critical for the suppression of ESD, Electrical Fast Transient (EFT) and surge transients. The following guidelines are recommended:

1. Place the device as close to the input terminal or connector as possible.
2. Minimize the path length between the device and the protected line.
3. Keep parallel signal paths to a minimum.
4. Avoid running protected conductors in parallel with unprotected conductors.
5. Minimize all Printed-Circuit Board (PCB) conductive loops including power and ground loops.
6. Minimize the length of the transient return path to ground.
7. Avoid using shared transient return paths to a common ground point.
8. Use ground planes whenever possible. For multilayer PCBs, use ground vias.

11. Package outline

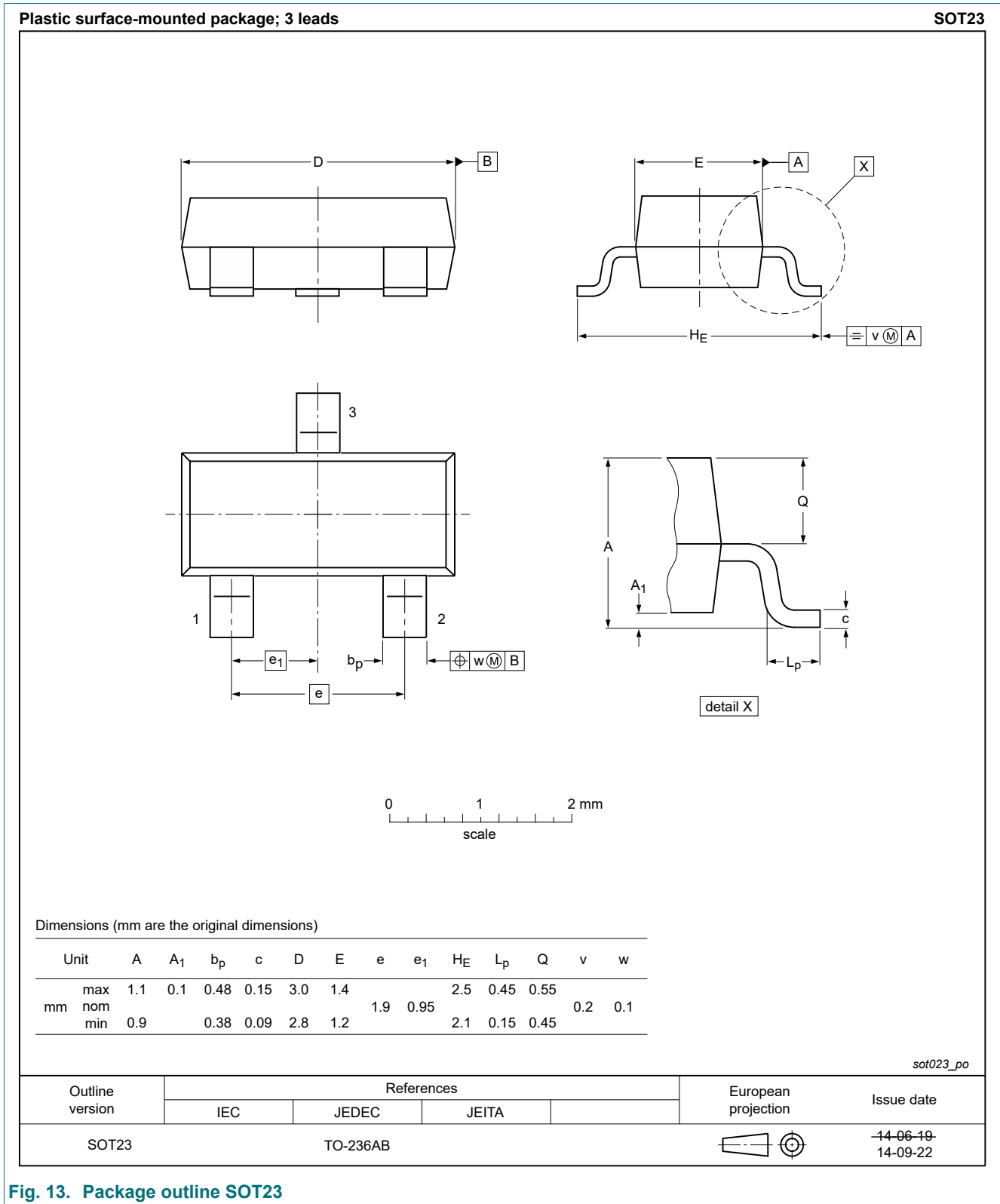

Fig. 13. Package outline SOT23

12. Soldering

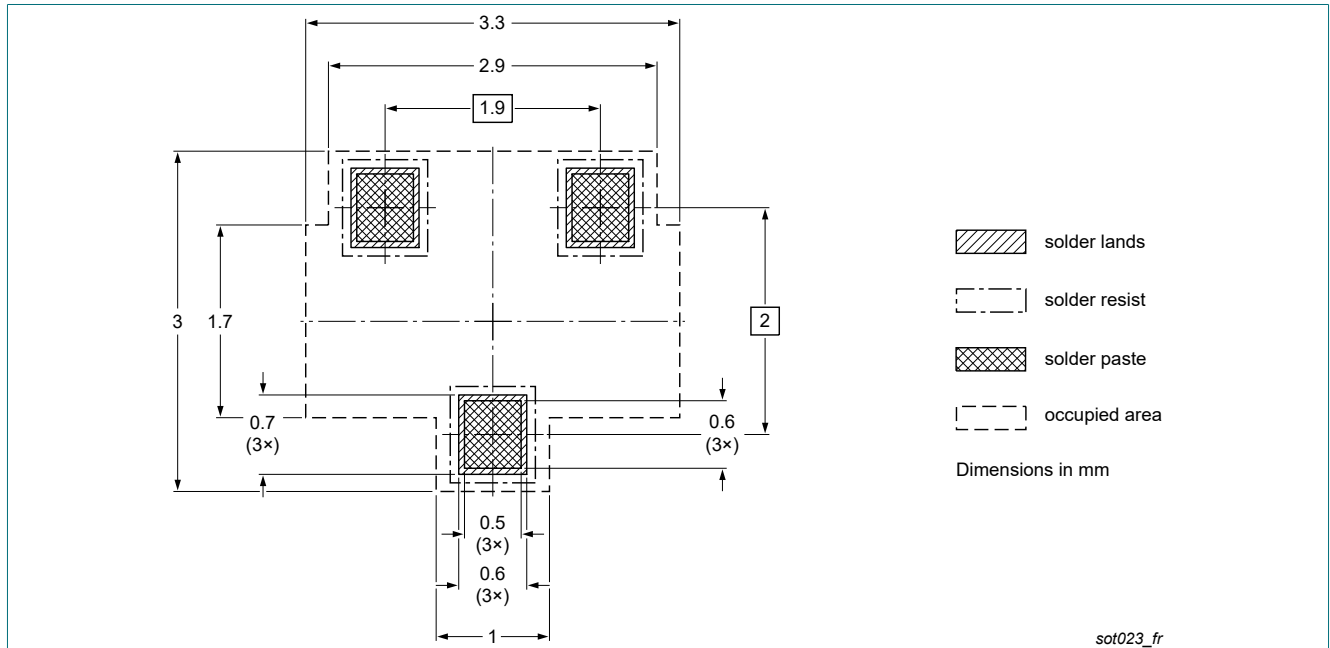

Fig. 14. Reflow soldering footprint for SOT23

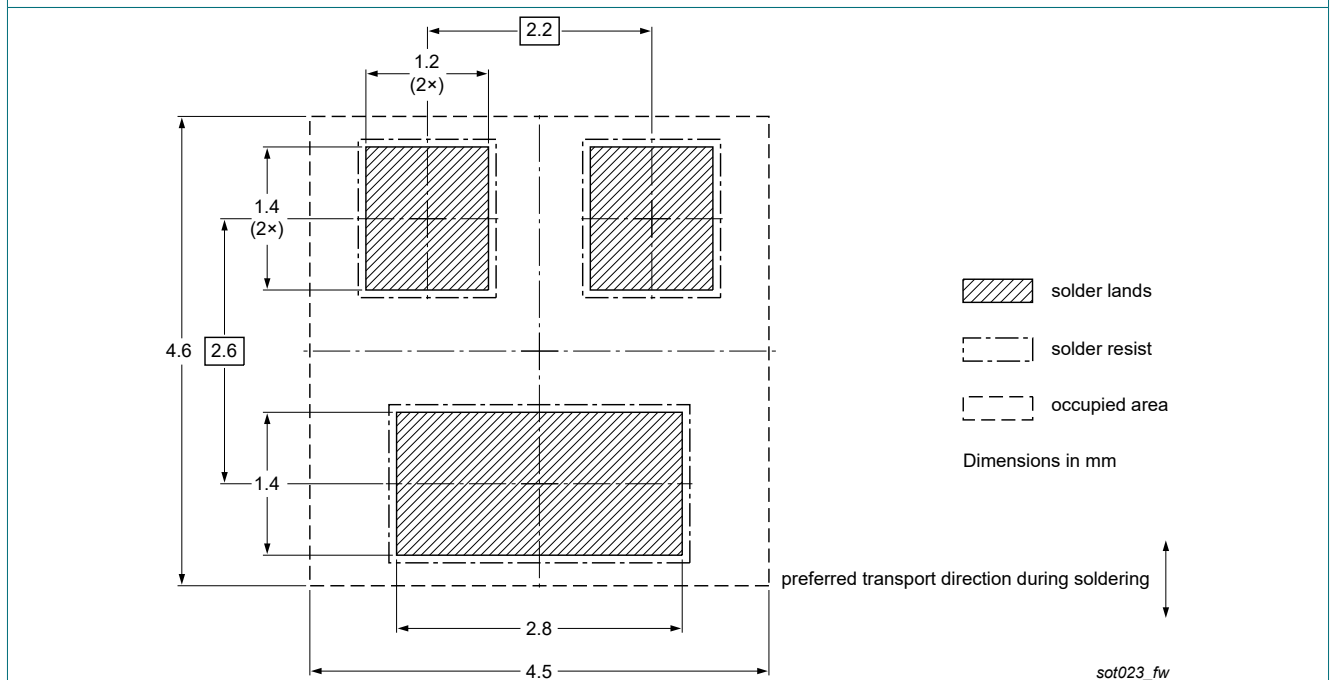

Fig. 15. Wave soldering footprint for SOT23

13. Revision history

Table 7. Revision history

| Data sheet ID | Release date | Data sheet status | Change notice | Supersedes |
|------------------|--|--------------------|---------------|------------------|
| PESD2IVN24-T v.3 | 20251119 | Product data sheet | - | PESD2IVN24-T v.2 |
| Modifications: | • Chapter "Characteristics": Update of Fig. 4 to 6 | | | |
| PESD2IVN24-T v.2 | 20180201 | Product data sheet | - | PESD2IVN24-T v.1 |
| PESD2IVN24-T v.1 | 20171012 | Product data sheet | - | - |

14. Legal information

Data sheet status

| Document status [1][2] | Product status [3] | Definition |
|--------------------------------|--------------------|---|
| Objective [short] data sheet | Development | This document contains data from the objective specification for product development. |
| Preliminary [short] data sheet | Qualification | This document contains data from the preliminary specification. |
| Product [short] data sheet | Production | This document contains the product specification. |

- [1] Please consult the most recently issued document before initiating or completing a design.
- [2] The term 'short data sheet' is explained in section "Definitions".
- [3] The product status of device(s) described in this document may have changed since this document was published and may differ in case of multiple devices. The latest product status information is available on the internet at <https://www.nexperia.com>.

Definitions

Draft — The document is a draft version only. The content is still under internal review and subject to formal approval, which may result in modifications or additions. Nexperia does not give any representations or warranties as to the accuracy or completeness of information included herein and shall have no liability for the consequences of use of such information.

Short data sheet — A short data sheet is an extract from a full data sheet with the same product type number(s) and title. A short data sheet is intended for quick reference only and should not be relied upon to contain detailed and full information. For detailed and full information see the relevant full data sheet, which is available on request via the local Nexperia sales office. In case of any inconsistency or conflict with the short data sheet, the full data sheet shall prevail.

Product specification — The information and data provided in a Product data sheet shall define the specification of the product as agreed between Nexperia and its customer, unless Nexperia and customer have explicitly agreed otherwise in writing. In no event however, shall an agreement be valid in which the Nexperia product is deemed to offer functions and qualities beyond those described in the Product data sheet.

Disclaimers

Limited warranty and liability — Information in this document is believed to be accurate and reliable. However, Nexperia does not give any representations or warranties, expressed or implied, as to the accuracy or completeness of such information and shall have no liability for the consequences of use of such information. Nexperia takes no responsibility for the content in this document if provided by an information source outside of Nexperia.

In no event shall Nexperia be liable for any indirect, incidental, punitive, special or consequential damages (including - without limitation - lost profits, lost savings, business interruption, costs related to the removal or replacement of any products or rework charges) whether or not such damages are based on tort (including negligence), warranty, breach of contract or any other legal theory.

Notwithstanding any damages that customer might incur for any reason whatsoever, Nexperia's aggregate and cumulative liability towards customer for the products described herein shall be limited in accordance with the Terms and conditions of commercial sale of Nexperia.

Right to make changes — Nexperia reserves the right to make changes to information published in this document, including without limitation specifications and product descriptions, at any time and without notice. This document supersedes and replaces all information supplied prior to the publication hereof.

Suitability for use in automotive applications — This Nexperia product has been qualified for use in automotive applications. Unless otherwise agreed in writing, the product is not designed, authorized or warranted to be suitable for use in life support, life-critical or safety-critical systems or

equipment, nor in applications where failure or malfunction of an Nexperia product can reasonably be expected to result in personal injury, death or severe property or environmental damage. Nexperia and its suppliers accept no liability for inclusion and/or use of Nexperia products in such equipment or applications and therefore such inclusion and/or use is at the customer's own risk.

Quick reference data — The Quick reference data is an extract of the product data given in the Limiting values and Characteristics sections of this document, and as such is not complete, exhaustive or legally binding.

Applications — Applications that are described herein for any of these products are for illustrative purposes only. Nexperia makes no representation or warranty that such applications will be suitable for the specified use without further testing or modification.

Customers are responsible for the design and operation of their applications and products using Nexperia products, and Nexperia accepts no liability for any assistance with applications or customer product design. It is customer's sole responsibility to determine whether the Nexperia product is suitable and fit for the customer's applications and products planned, as well as for the planned application and use of customer's third party customer(s). Customers should provide appropriate design and operating safeguards to minimize the risks associated with their applications and products.

Nexperia does not accept any liability related to any default, damage, costs or problem which is based on any weakness or default in the customer's applications or products, or the application or use by customer's third party customer(s). Customer is responsible for doing all necessary testing for the customer's applications and products using Nexperia products in order to avoid a default of the applications and the products or of the application or use by customer's third party customer(s). Nexperia does not accept any liability in this respect.

Limiting values — Stress above one or more limiting values (as defined in the Absolute Maximum Ratings System of IEC 60134) will cause permanent damage to the device. Limiting values are stress ratings only and (proper) operation of the device at these or any other conditions above those given in the Recommended operating conditions section (if present) or the Characteristics sections of this document is not warranted. Constant or repeated exposure to limiting values will permanently and irreversibly affect the quality and reliability of the device.

Terms and conditions of commercial sale — Nexperia products are sold subject to the general terms and conditions of commercial sale, as published at <http://www.nexperia.com/profile/terms>, unless otherwise agreed in a valid written individual agreement. In case an individual agreement is concluded only the terms and conditions of the respective agreement shall apply. Nexperia hereby expressly objects to applying the customer's general terms and conditions with regard to the purchase of Nexperia products by customer.

No offer to sell or license — Nothing in this document may be interpreted or construed as an offer to sell products that is open for acceptance or the grant, conveyance or implication of any license under any copyrights, patents or other industrial or intellectual property rights.

Export control — This document as well as the item(s) described herein may be subject to export control regulations. Export might require a prior authorization from competent authorities.

Translations — A non-English (translated) version of a document is for reference only. The English version shall prevail in case of any discrepancy between the translated and English versions.

Trademarks

Notice: All referenced brands, product names, service names and trademarks are the property of their respective owners.

Contents

| | |
|----------------------------------|----|
| 1. General description..... | 1 |
| 2. Features and benefits..... | 1 |
| 3. Applications..... | 1 |
| 4. Quick reference data..... | 1 |
| 5. Pinning information..... | 2 |
| 6. Ordering information..... | 2 |
| 7. Marking..... | 2 |
| 8. Limiting values..... | 3 |
| 9. Characteristics..... | 4 |
| 10. Application information..... | 7 |
| 11. Package outline..... | 8 |
| 12. Soldering..... | 9 |
| 13. Revision history..... | 10 |
| 14. Legal information..... | 11 |

© Nexperia B.V. 2025. All rights reserved

For more information, please visit: <http://www.nexperia.com>

For sales office addresses, please send an email to: salesaddresses@nexperia.com

Date of release: 19 November 2025
